

Hanex® Solid Surfaces

# Hanex® Solid Surfaces

Design Flexibility · Durability · Beauty



Hanwha L&C Corp.

7F Center1, 26, Eulji-ro, 5-Gil, Jung-gu, Seoul 100-210, Korea  
Tel. 82. 2. 6364. 7814 law0410@hanwha.com, 82. 2. 6364. 7816 rickkim@hanwha.com, 82. 2. 6364. 7817 dhwanim@hanwha.com  
www.hanex-i.com

HanwhaL&C  
V 201609





# Hanex® Solid Surfaces

Design Flexibility · Durability · Beauty

**CONTENTS**

- 04 Introduction
- 06 '16 New Collection - Stratum
- 12 New Collection - Bellissimo
- 26 Project References
- 46 Color Index
- 50 Sink Bowls
- 52 Technical Data



Facade



Hospital



Office



Public Area



Camper Van



Restaurant



Bath

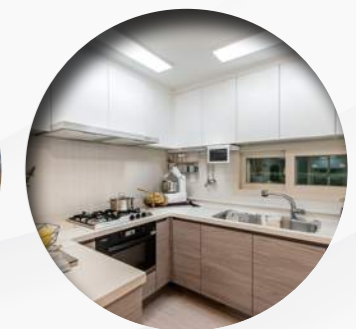

Kitchen



# One Inspirational Surface



BL-206 SLATE GREY

Hanex® solid surfaces can be fabricated and installed in almost any residential or commercial application with inconspicuous seams.

Rich colours and textures.  
Superior function and form.  
Discover the many unique benefits of Hanex®.  
The only limitation of Hanex® is your imagination.



BL-207 BORDEUX

- Easy to fabricate designs envisioned by designers or architects
- Highly durable
- Maintains its colour and shape
- Resistant to heat, mould, pollutants and bacteria
- Renewable, repairable & environmentally friendly
- Easy to care for & maintain – scratch & stain resistant
- Extensive colour range
- 10 Years limited warranty
- Endless design possibilities
- Hanex® achieves the highest for classification – en13501-1b

## Hanex® Solid Surfaces



**HANEX® products are non-porous and certified NSF51 for food preparation areas. Therefore, they can be applied in any application where sanitation is of utmost importance, such as kitchen worksurfaces, hospitals, playrooms or schools.**

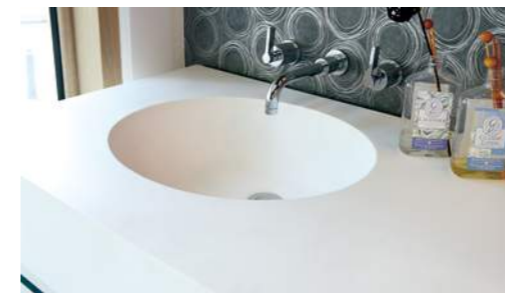

The unlimited design flexibility of HANEX® enables you to create a beautiful and durable aesthetic in any commercial setting, be it a hospital, bank, restaurant, hotel or office space. Commercial applications include : Office/hospitality and medical counters & worksurfaces, reception desks, bathroom worksurfaces and vanities, tabletops, food preparation areas, commercial fitouts including aesthetically seamless wall cladding, lift & foyer surrounds, lighting and more...

## Hanex® Achieves The Following

### Fire Certification EN13501-1b

This is the European Fire classification relating to all construction products, including products incorporated within building elements. Products are considered in relation to their end use application. HANEX® achieves EN13501-1b which is comparable to B5476 Class 0.

### NSF51 Certification

This Standard is applicable to the materials and finishes used in the manufacture of food equipment (e.g., beverage dispenser, cutting board, work surfaces, etc).

### Green guard Certification

Indoor Air Quality Certification ensures that products meet indoor air quality pollutant guide lines/standards.

### Stain Resistance Report

HANEX® is an acrylic solid surface material product with a high level of alumina trihydrate content as the filler, an ingredient which provides superior resistance to stains and chemicals. However, exposure to harsh chemicals should be avoided. In case of surface contamination, quickly flush affected area with a domestic gritty cleaner and water. Sand if necessary, as a rule of thumb, surface damage may vary with the chemical strength and exposure time.

### Scientific Certification Systems

These certificates relate to recycled chips in use in our material.

Certificates available at [www.hanex-i.com](http://www.hanex-i.com)



Hanex® Solid Surfaces

'16 NEW COLLECTION

# STRATUM

In a worldly perspective and soft range of colors with large, organic patterns, you discover the artistic, unconventional scene of the nature.

Enjoy the new view of the earth.

## Color Index

The sample images of this collection are photographed in one to one (1:1) ratio.



ST 101 CLARA



ST 104 ARDOSIA

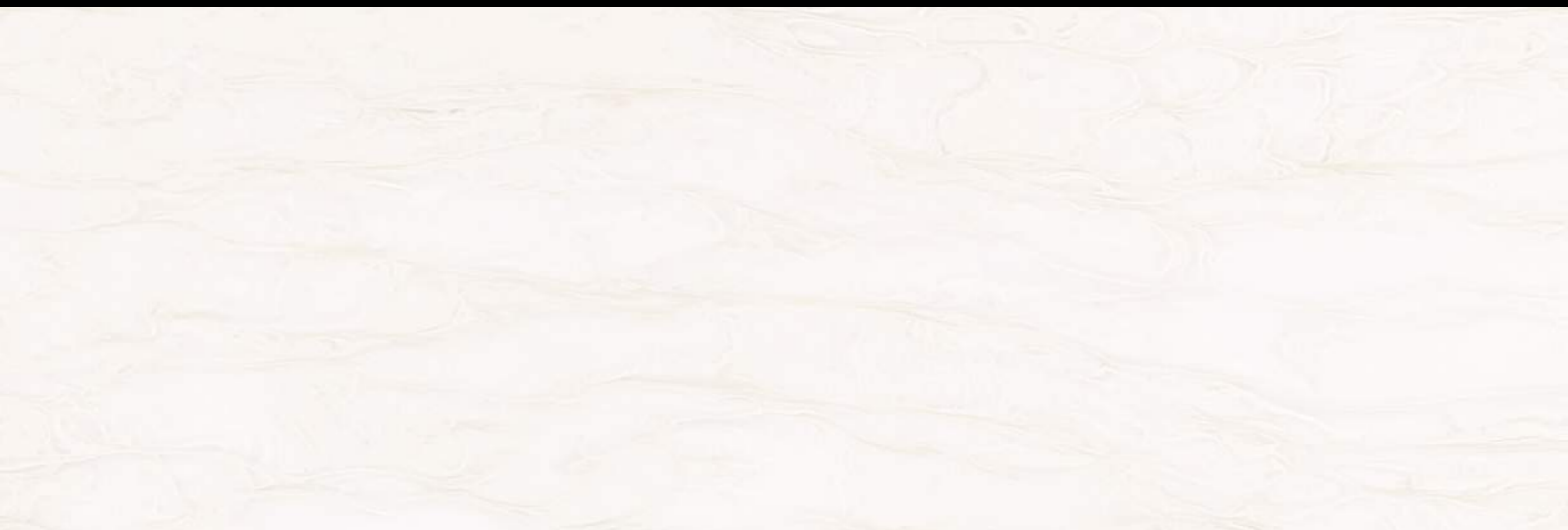

ST 102 MARELINHO



ST 105 MORENO



ST 103 NUBLADO



ST 106 GRENCIO

\*Colors may vary from actual production

# STRATUM

'16 New Collection



Hanex® Solid Surfaces

**BELLASSIMO**  
**EPISODE II**

Experience the greatness and grandeur in our new collection, Bellassimo Episode II. Inspired by patterns and colors in the elements in nature such as rock, wood, and plant. The Bellassimo Episode II creates far more luxurious and sophisticated space.



## Color Index

The sample images of this collection are photographed in one to one (1:1) ratio.



BL-217 MON BLANC



BL-251 CAMEO

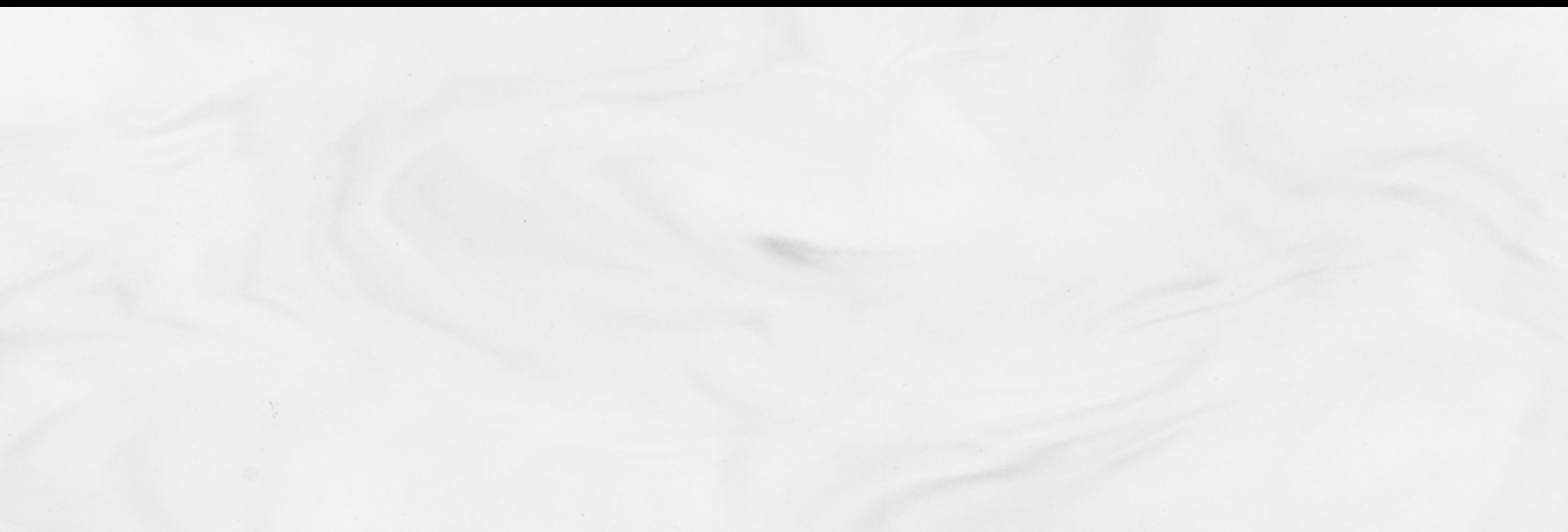

BL-218 MARFIM



BL-202 FLAXEN



BL-201 KASHMERE



BL-203 SILKWOOD



BL-204 SEAWAY



BL-207 BORDEUX



BL-205 SEDIMENTARY



BL-209 MACASSAR



BL-206 SLATE GREY

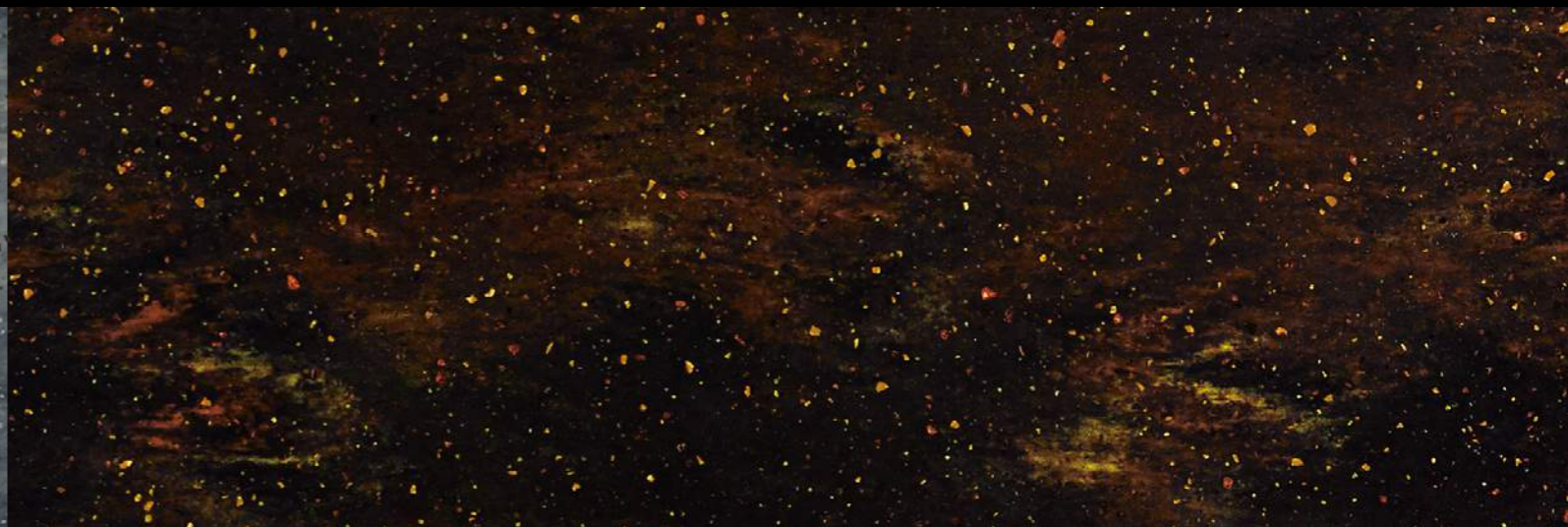

BL-253 EBONY TIMBER

# BELLASSIMO

Location Seoul, Korea  
Color BL-207 Bordeaux, BL-206 Slate Grey  
Project Center1



BL-014 STRATUS



BL-002 CELADON



BL-015 CHAMPAGNE



BL-003 PIETRA PANNA



BL-016 CUMULUS



BL-010 TERRACOTTA

**Note!**

The Bellassimo decors are veined and small samples may not show the veining effect. Ensure you are aware of the overall look of the Bellassimo product prior to purchase and fabrication of the Sheets. Please note that covered upstands highlight the vein through the product and edges should always be rebated on these decors.

All dark décors are prone to show scratches, dust, haziness and ordinary wear and tear more easily than lighter textured décors. Therefore, these décors are not recommended for use in residential and commercial applications that will be subject to heavy use.

\*Colors may vary from actual production



# BELLASSIMO



**Location** New Jersey, USA  
**Color** BL-204 Seaway  
**Project** Private house, Trenton



**Location** Seoul, Korea  
**Color** BL-201 Kashmere  
**Project** Café Arinco



**Location** Gwangju, Korea  
**Color** BL-209 Macassar  
**Project** Kitchen Showroom



**Location** Seoul, Korea  
**Color** BL-203 Silkwood  
**Project** Café Arinco

## BELLASSIMO



**Location** Taipei, Taiwan  
**Color** BL-002 Celadon  
**Project** Team7 Furniture

Location Seoul, Korea  
Color BL-205 Sedimentary  
Project Café Arinco



Location Taipei, Taiwan  
Color BL-003 Pietra Panna  
Project Team7 Furniture



Location Seoul, Korea  
Color BL-207 Bordeaux  
Project Private Object



# PUBLIC PLACE

COMMERCIAL

Location Frankfurt, Germany  
Color S-008 N-White  
Project Asos Shop



Location Seoul, Korea  
Color S-008 N-White  
Project Galleria Dept. Store



Location Seoul, Korea  
Color S-008 N-White  
Project Toyota at Seoul Motor Show

Location Bangkok, Thailand  
Color S-008 N-White  
Project Nokia Flagship Store





Location Seoul, Korea  
Color S-008 N-White  
Project Coex Mall



Location Seoul, Korea  
Color S-008 N-White  
Project Toyota at Seoul Motor Show



Location Bangkok, Thailand  
Color S-008 N-White  
Project Zpell Dept. Store



# RESTAURANT

COMMERCIAL

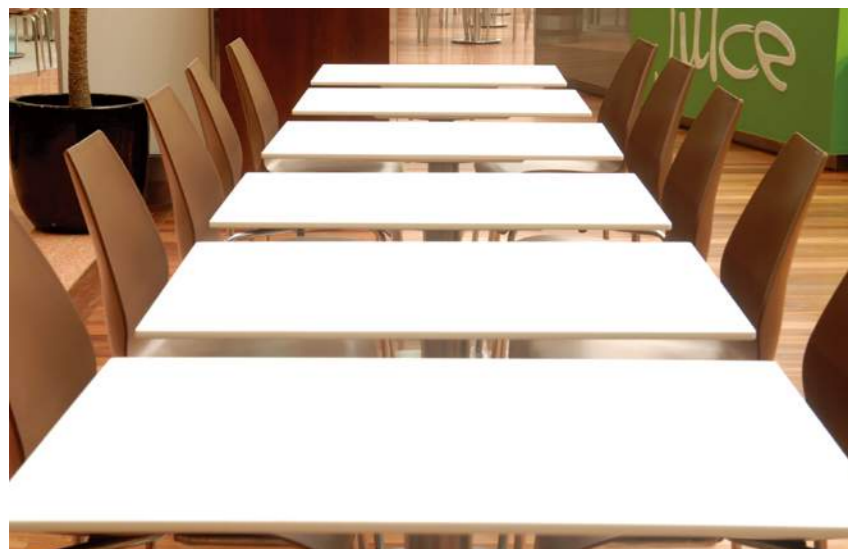
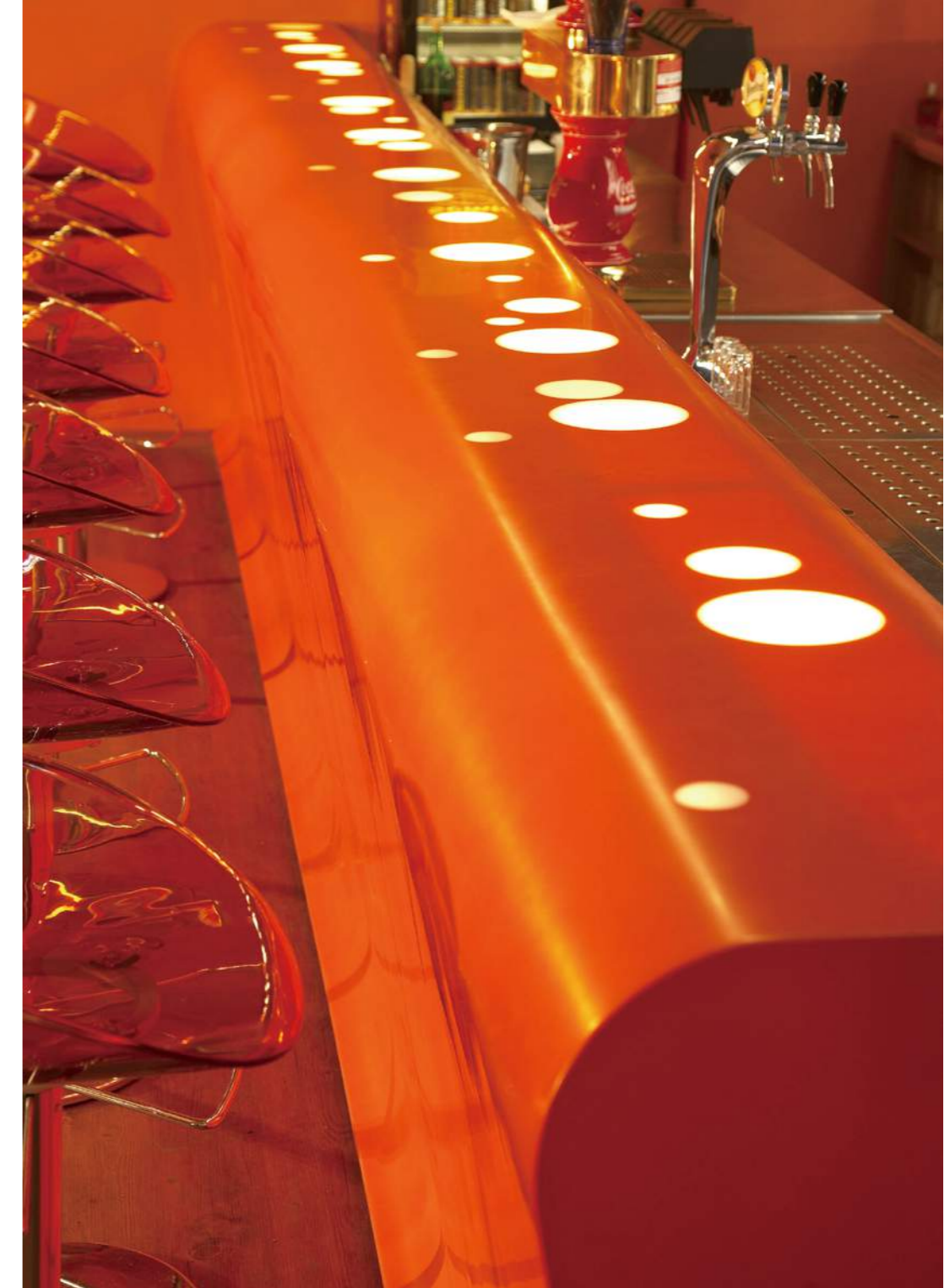

Location Seoul, Korea  
Color S-008 N-White  
Project Somersat Thailand

Location Hochiminh, Vietnam  
Color S-008 N-White  
Project Lotteria



Location Prague, Czech Republic  
Color S-008 N-White  
Project Bar Oranzovy

OFFICE  
COMMERCIAL



Location Seoul, Korea  
Color S-008 N-White  
Project Private Office



Location Kingston, Canada  
Color C-001 Cubic White  
Project HDR Design



Location Seoul, Korea  
Color BL-001 Stratus  
Project Center1, Seoul

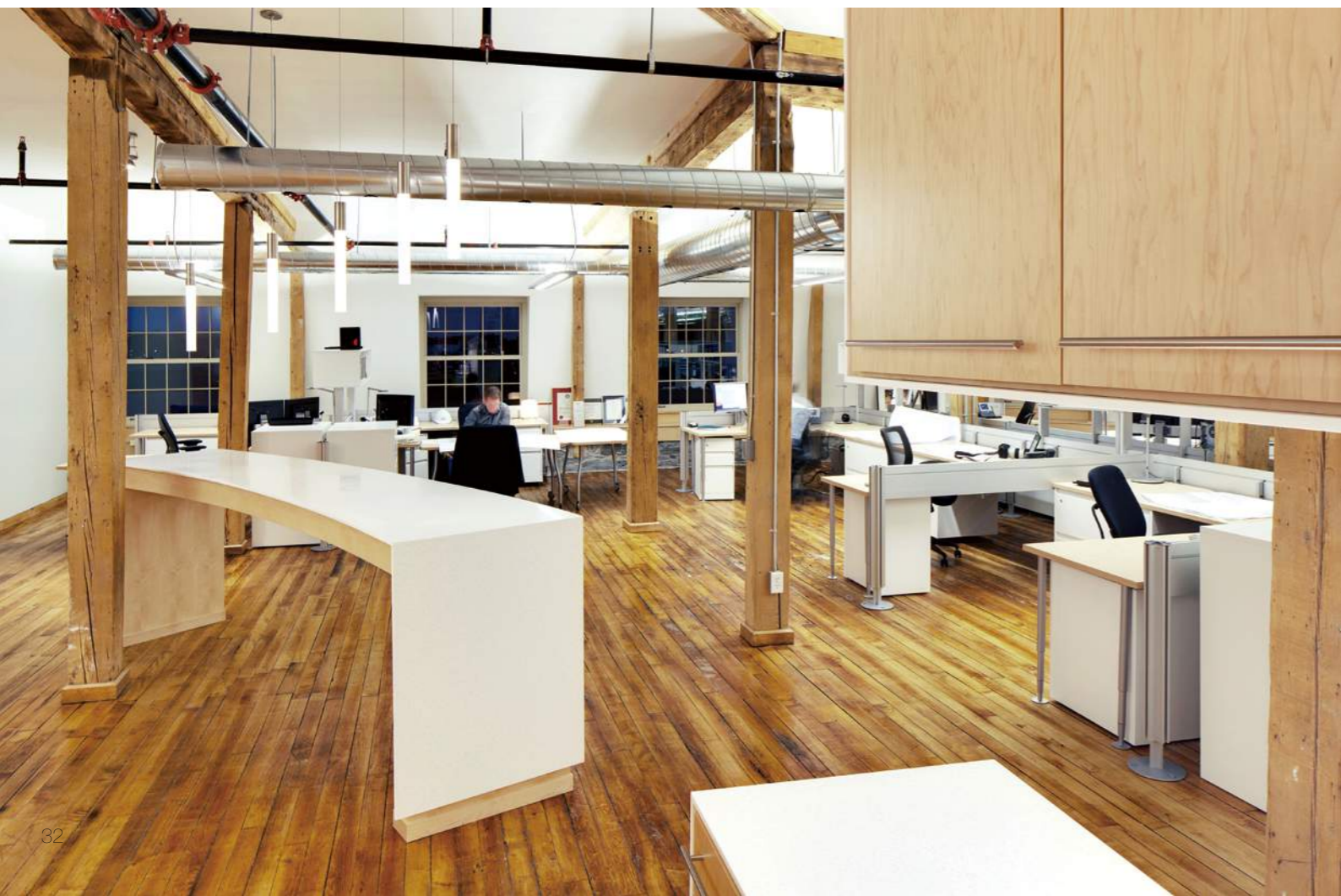

Location Hochiminh, Vietnam  
Color S-008 N-White  
Project ACB Bank



Location Prague, Czech Republic  
Color C-004 Cubic Milk  
Project Slavie

# HOSPITAL

COMMERCIAL



Location Seoul, Korea  
 Color S-008 N-White  
 Project Gangnam Public Convalescent Hospital



Location Seoul, Korea  
 Color S-008 N-White  
 Project Private Dental Clinic



Location Seoul, Korea  
 Color S-008 N-White  
 Project Gangnam Public Convalescent Hospital

# FACADE

COMMERCIAL



Location Dubai, UAE  
Color S-008 N-White  
Project HUES Boutique Hotel



Location Munich, Germany  
Color S-008 N-White  
Project Zwischen Ablage



Location Shanghai, China  
Color S-008 N-White  
Project HLTS Office



# CAMPER VAN

COMMERCIAL



Location Kentucky, USA  
Color BL-017 Twister  
Project RV Show, Louisville



Location Kentucky, USA  
Color BL-017 Twister  
Project RV Show, Louisville



Location Gyeonggi, Korea  
Color S-019 Brown Fever  
Project Doosung Camper Van

# KITCHEN

RESIDENTIAL



Location Gyeongju, Korea  
Color T-201 Feta Cheese  
Project SG Misoziium Condominium



Location Taipei, Taiwan  
Color GAM-001 Aftersnow  
Project Team7 Furniture

Location Jeju, Korea  
Color NA-01 Blando  
Project Seohan Industry





Location Taipei, Taiwan  
 Color GAM-001 Aftersnow  
 Project Team7 Furniture



Location Seoul, Korea  
 Color C-001 Cubic White  
 Project Lotte Castle



Location Seoul, Korea  
 Color S-008 N-White  
 Project Hyundai Livart Ritchen

# BATH

RESIDENTIAL



Location NSW, Australia  
Color S-008 N-White  
Project SCF Interiors, Wareemba



Location Moscow, Russia  
Color S-008 N-White  
Project City Hotel



Location Beijing, China  
Color S-008 N-White  
Project Opera Mall



Location Singapore, Singapore  
Color C-001 Cubic White  
Project Minton Condominium

Location Daejeon, Korea  
Color S-008 N-White  
Project Private House



Location Seoul, Korea  
Color S-008 N-White  
Project Hanwha L&C Showroom

# Hanex® Standard Collection

## Solo



## Duo



## Pearl

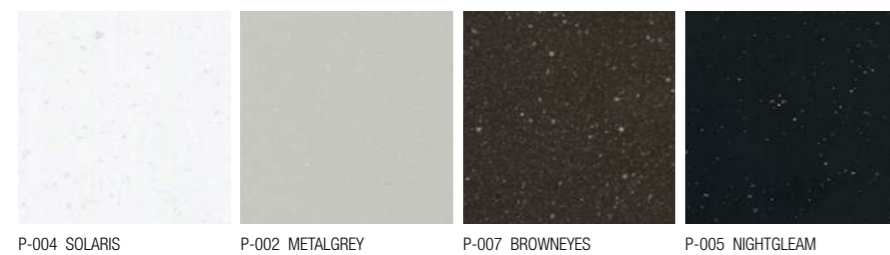

## Trio



## Cubic

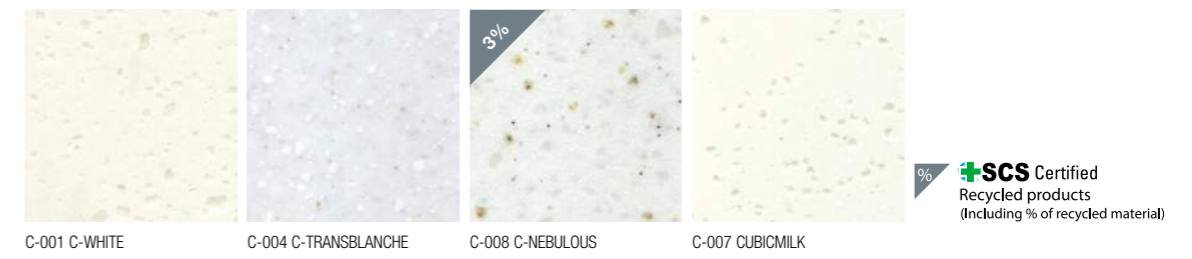

## Magic

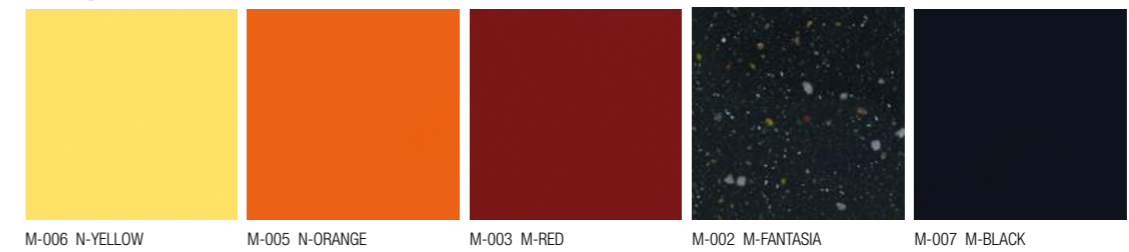

## Therapy Collection

'THERAPY' is the eco-friendly collection which provides the organic and natural look. These products are manufactured with recycled resources so that you could heal the environment with this 'THERAPY' series.

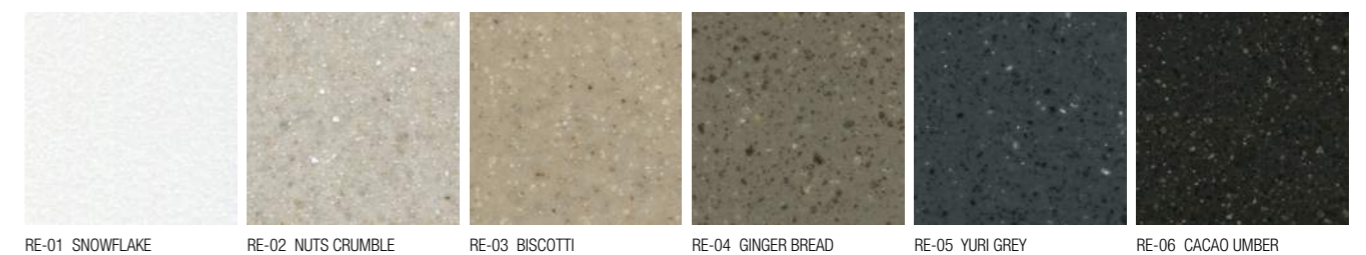

Galleria

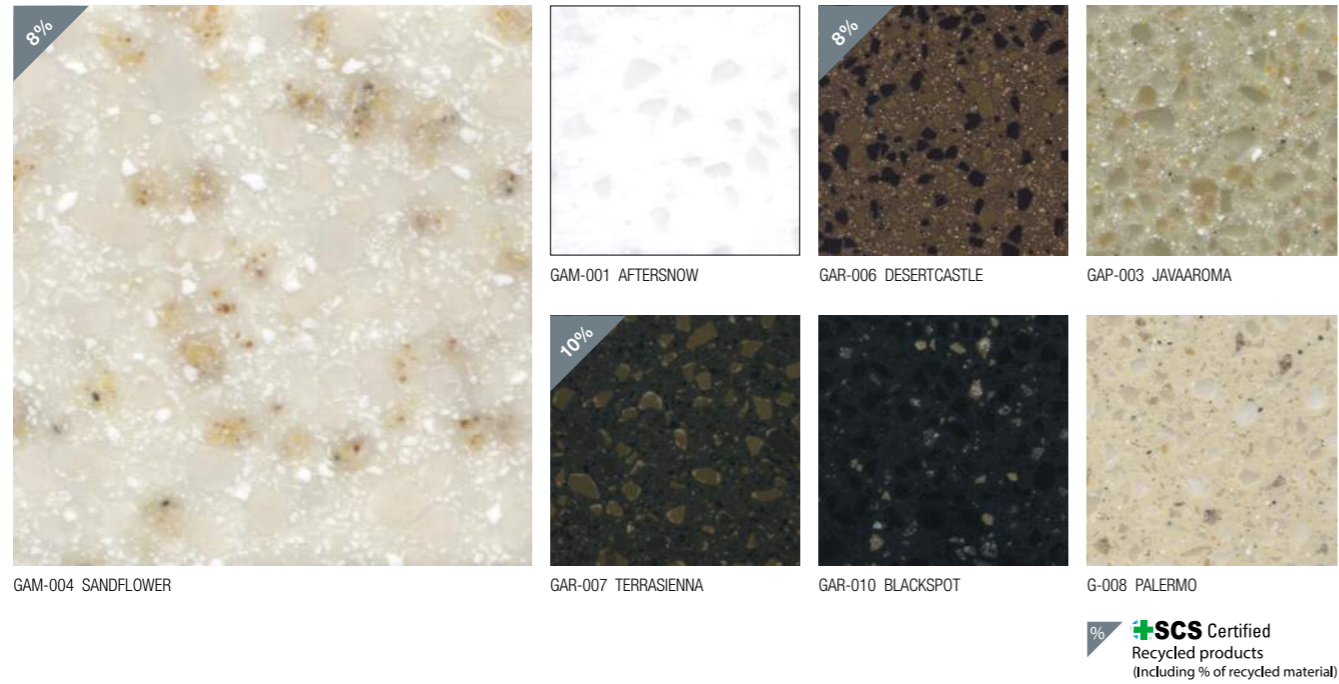

Glittering

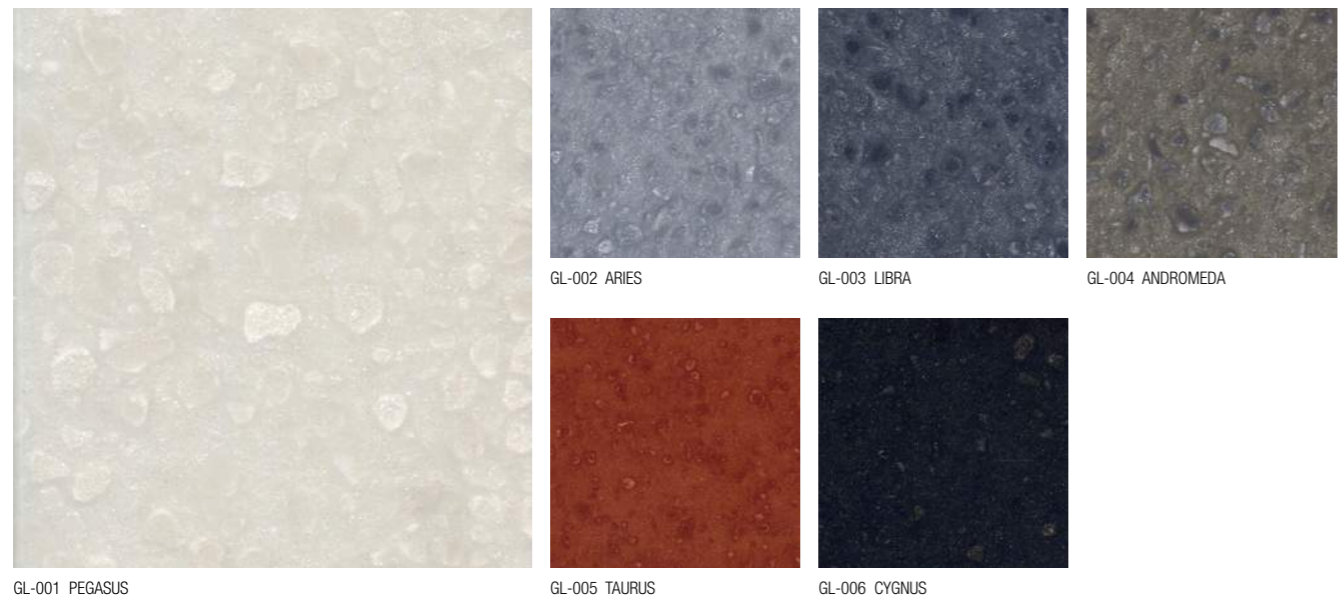

All dark décors are prone to show scratches, dust, haziness and ordinary wear and tear more easily than lighter textured décors. Therefore, these décors are not recommended for use in residential and commercial applications that will be subject to heavy use.

Brionne

Reflects the natural essence of solid stone.

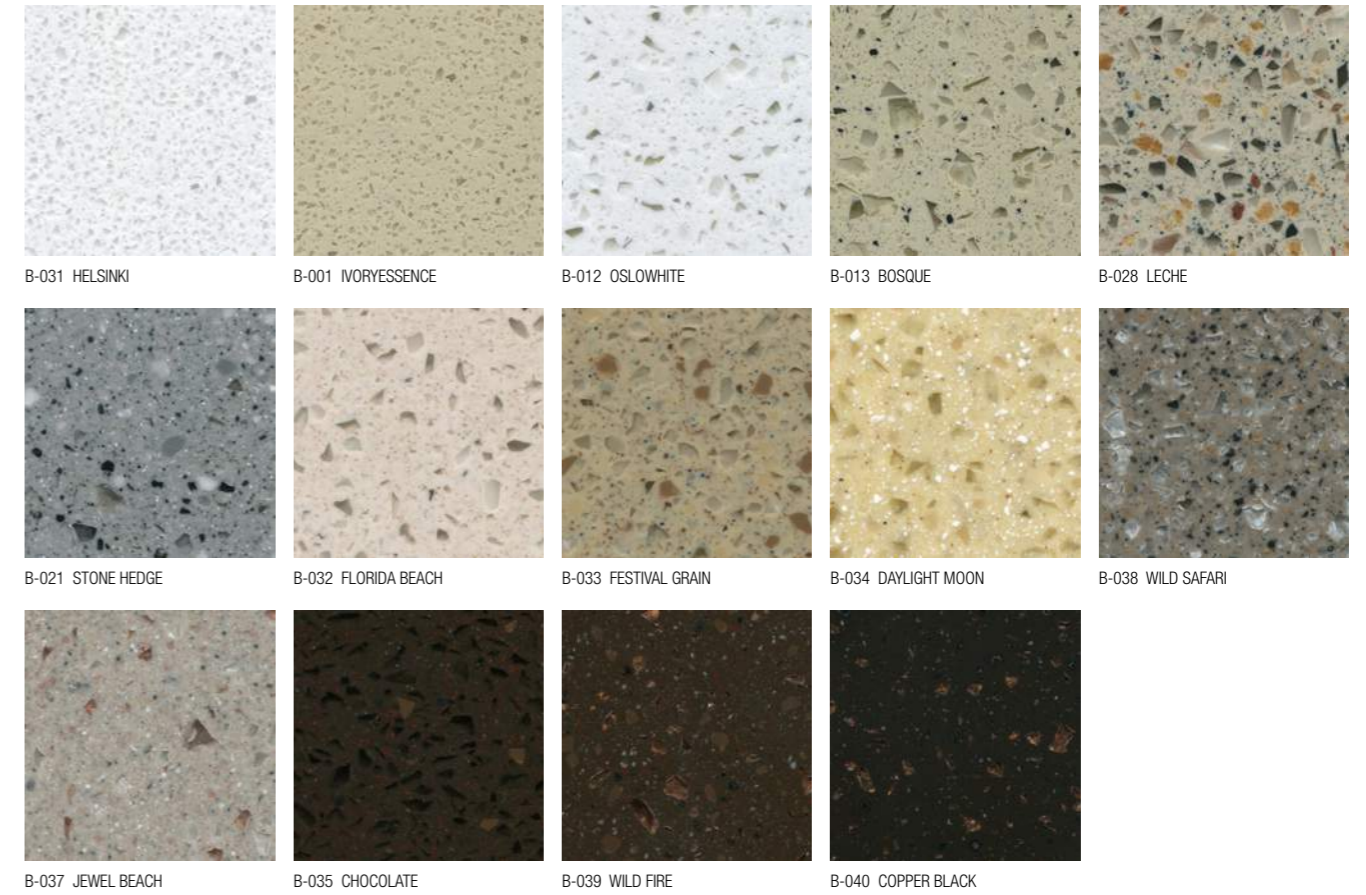

Nativo Collection

The new and premium collection 'NATIVO' resembles distinguished and premium look of nature. The unique atypical chips and tone-on-tone colors in 'NATIVO' create the natural and wild look which solid surfaces never had before.

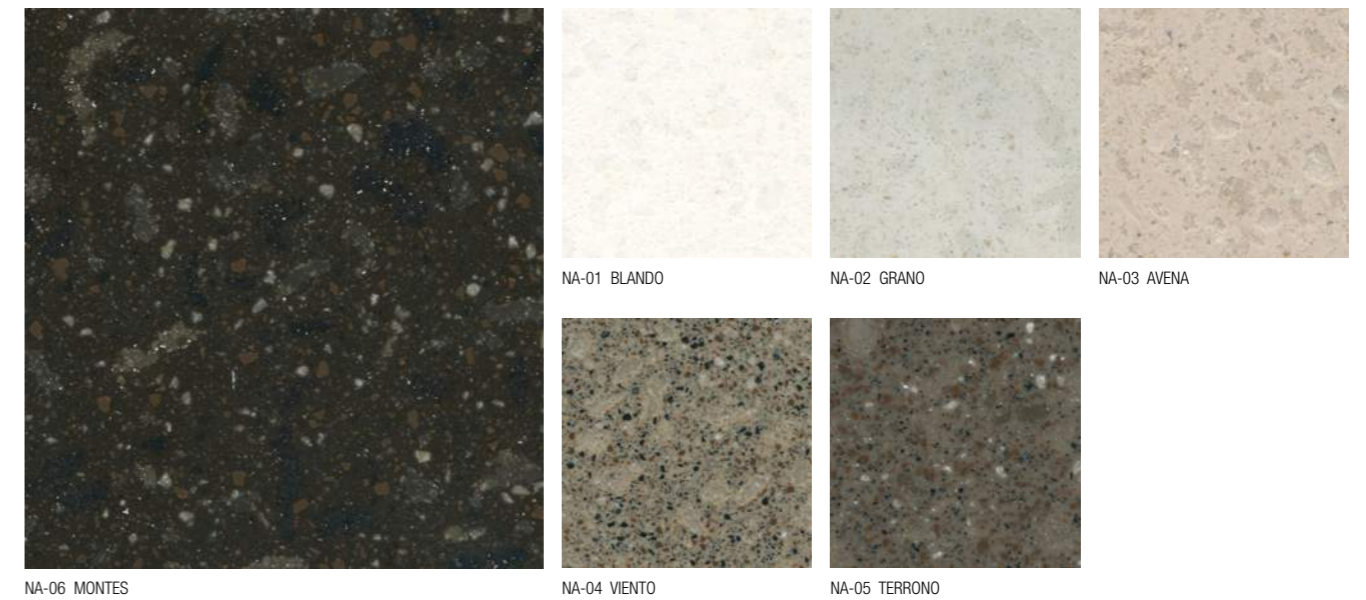

\*Colors may vary from actual production

Single Sinks

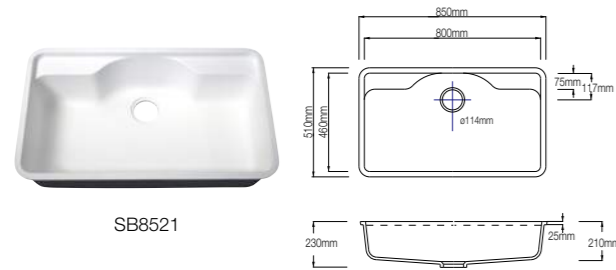

SB8521

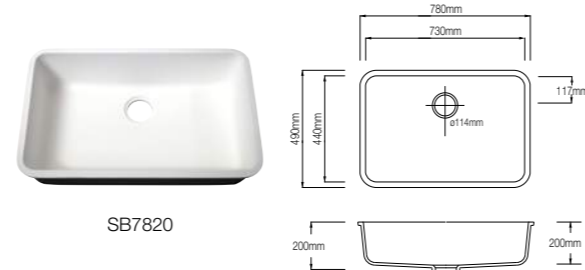

SB7820

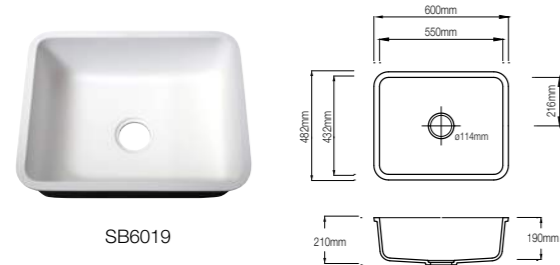

SB6019

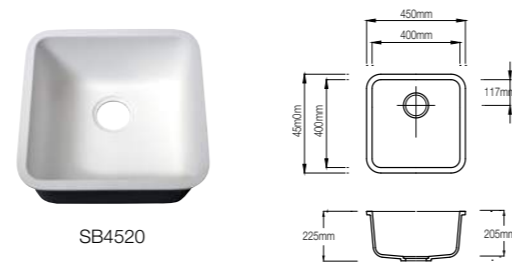

SB4520

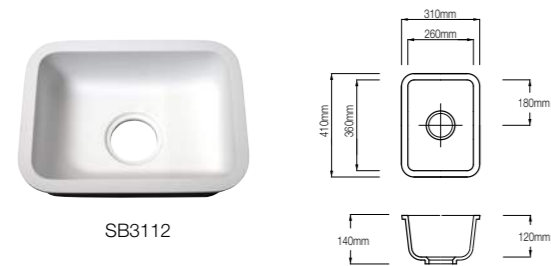

SB3112

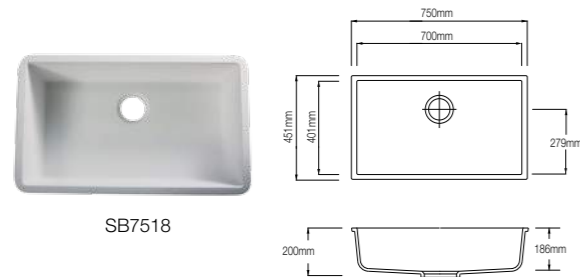

SB7518

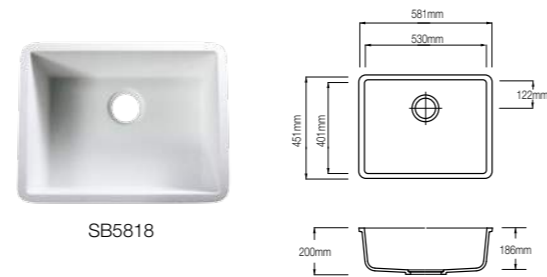

SB5818

Double Sinks

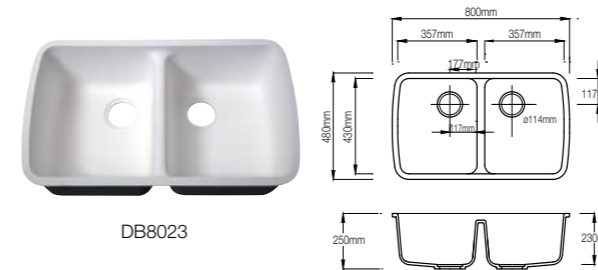

DB8023



DB8819

Bowls

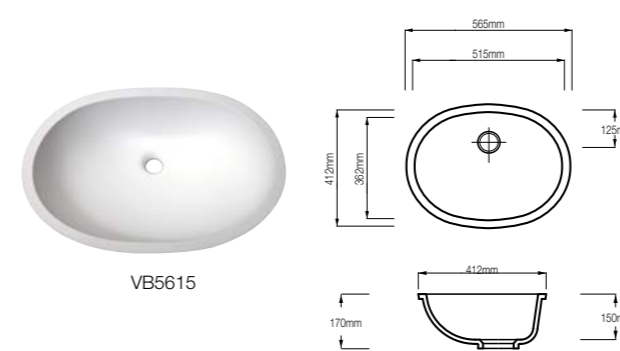

VB5615

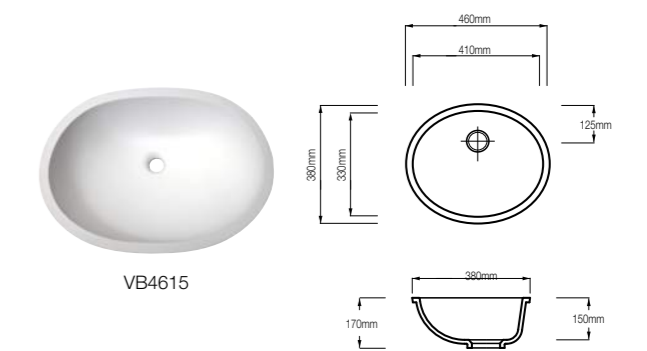

VB4615

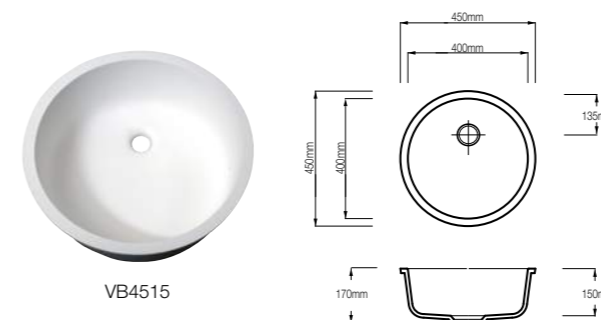

VB4515

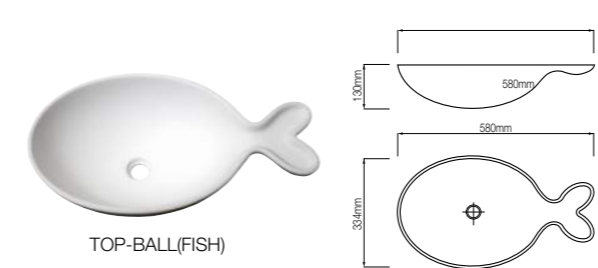

TOP-BALL(FISH)

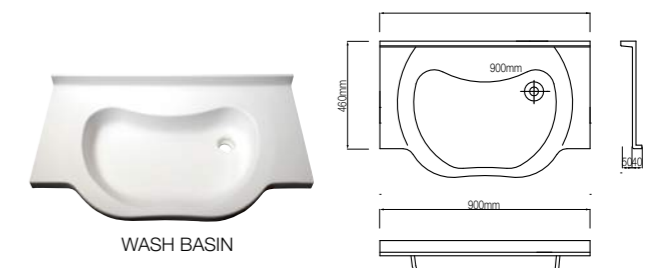

WASH BASIN

Colours available

S-008 N-WHITE & S-004 IVORY other colors upon request, please contact your local Hanex Distributor All casted sinks are covered by 10 year manufacturers warranty.

Features

- 100% acrylic Sinks & Bowls
- Excellent quality and design
- Available to make the customized designs
- Good color matching with solid surface
- Available in even small quantity(HANEX model)

Available in Solo category with matching solid surface or stainless steel base. All fabricated sinks are covered by 10 year manufacturers warranty. Delivery lead-times will apply as these sinks are manufactured to order.

# Hanex<sup>®</sup> Material Safety Data Sheet

## Chemical Product And Company Identification

### Material Identification

HANEX (HANEX is a registered trademark of HANWHA L&C CORP.)

### Company Identification Manufacturer

HANWHA LIVING & CREATIVE CORP.

7F Center1, 26, Eulji-ro, 5-Gil, Jung-gu, Seoul 100-210, Korea

### Contact Details For Information

HANWHA LIVING & CREATIVE CORP.

7F Center1, 26, Eulji-ro, 5-Gil, Jung-gu, Seoul 100-210, Korea

Ph: +82 2 6364 7817 Fax: +82 2 6367 7809

## Composition And Information On Ingredients

Component	CAS	%
Polymethylmethacrylate	8011-14-7	>30
Alumina Trihydrate	21645-51-2	<70
Methylmethacrylate (Degradation Product)	80-62-6	<1

Heated above 300 dCe,g “ HANEX” can release

## Fire-Fighting Measures And Explosion Hazard

### Flammable Properties

“HANEX” can be combusted only with difficulty.

Hazardous gases/vapor produced in fire are carbon monoxide, methyl methacrylate, aldehydes

### Extinguishing Media

Water, Dry chemical, CO<sub>2</sub>

### Fire Fighting Instructions

Keep personnel removed and upwind of fire.

Wear self-contained breathing apparatus.

## Accidental Release Measures

### Safeguard (Personnel)

NOTE : Review FIRE FIGHTING MEASURES and HANDLING (PERSONNEL) sections before proceeding with clean-up.

Use appropriate PERSONAL PROTECTIVE during clean up.

### Spill Clean Up

Recover undamaged and minimally contaminated material for reuse and reclamation.

## Handling And Storage

### Handling (Personnel)

Avoid breathing dust.

Avoid breathing fumes generated during sawing, routing or drilling.

### Handling (Physical Aspects)

Avoid dust generation.

### Storage

Store in a cool place

## Exposure Controls And Personal Protection

### Engineering Controls (Ventilation)

Use ventilation that is adequate to keep employee exposure to air borne concentration below exposure limits.

### Personal Protection

Protective equipment: EYE/FACE PROTECTION

Wear safety glasses during operations such as sawing, sanding, drilling or routing.

## Toxicological Information

### Skin / Eye Irritant Polymethylmethacrylate

The compound is not a skin or eye irritant and is not a skin sensitizer in animals. Single or repeated ingestion produced mild degenerative changes of liver and kidney.

### Methyl Methacrylate

The compound is a skin irritant, is a moderate eye irritant, and is a skin sensitizer in animals.

### Alumina Trihydrateylate

The compound is untested for skin and eye irritant, and is untested for animal sensitization.

### Acute Toxicity (LC50)

POLYMETHYL METHACRYLATE

>2MG/1, 4hr LC50(Inhalation/Rat)

METHYL METHACRYLATE

7093PPM/4hr LC50(Inhalation/Rat)

### Acute Toxicity (LD50)

POLYMETHYL METHACRYLATE

>2000mg/kg, 4hr LD50(Oral/Cat)

METHYL METHACRYLATE

7900PPM/4hr LD50(Oral/Cat)

## Ecological Information

### BIODEGRADATION

No information is available

### BIOACCUMULTION

No information is available

### AQUATIC TOXICITY

No information is available

## Disposal Considerations

Dispose in accordance with federal, state and local regulation.

The owner of the material is responsible for proper waste disposal.

## Other Information

The data in this Material Safety Data Sheet relates only to the specific material designated herein and does not relate to use in combination with any other material or in any process.

Responsibility for MSDS : “HANEX” products

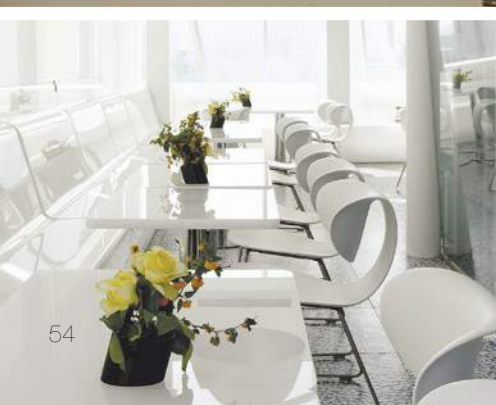

## Certificates



ISO

ISO

SGS



Greenguard

Greenguard



SCS GLOBAL

SCS GLOBAL



SCS GLOBAL



NSF INTERNATIONAL

## Hanex® Specification

### Technical Specification

Sample: Scagliola(HANEX) D

### Test Results

Test Item	Unit	Sample	Result	Test Method
Specific Gravity((23/23) °C)	-	-	1.756	ASTM D792-08(Method A)
Rockwell Hardness(HRM)	-	-	90	ASTM D785-08(Procedure A)
Tensile Strength	MPa	-	43.8	ASTM D638-10(*)
Tensile Modulus of Elasticity	GPa	-	12.6	ASTM D638-10(*)
Flexural Strength	MPa	-	58.8	ASTM D790-10(**)
Flexural Modulus of Elasticity	GPa	-	10.6	ASTM D790-10(**)
Izod Impact Strength	J/m	-	16	ASTM D256-10(Method A)
Water Absorption(24h Immersion)	%	-	0.036	ASTM D570-98(2010)e1
Density(23 °C)	g/cm <sup>2</sup>	-	1.751	ASTM D792-08(Method A)
Heat Resistance Test	-	-	No Defects	JIS K 6902 : 2008
Hot Water Resistance Test	-	-	No Defects	JIS K 6902 : 2008
Deflection Temperature Under(1.82 Mpa)	°C	-	115	ASTM D648-07(Method B)
Thermal Expansion	1/ °C	-	3.93×10-5	JIS K 6911 : 2006

\*Specimen: Type I, Speed of Testing: 5 mm/min(Modulus: 1 mm/min)

\*\*Speed of Testing: 5.2 mm/min, Support Span: 190 mm

USAGE: QUALITY CONTROL